

SANYO	No. 870D	LA4160
SINGLE-CHIP TAPE RECORDER AUDIO SYSTEM		

Features

- . A single package containing preamplifier, ALC circuit, power amplifier.
- . Preamplifier with high gain, and power amplifier with high gain and output.
1W typ. ($V_{CC}=6V, R_L=4ohms$)
2.2W typ. ($V_{CC}=9V, R_L=4ohms$)
- . Minimum number of external parts required.
- . Soft tone quality at the time of output saturation.
- . Wide range of ALC and small variation in output voltage.
- . Wide range of operating supply voltage.
- . Small shock noise at the time of supply voltage ON/OFF (With built-in prevention circuit).
- . Variable monitor capability due to recording amplifier consisting of pre-amplifier alone.

Maximum Ratings at $T_a=25^\circ C$

			unit
Maximum Supply voltage	V_{CCmax}	13	V
Allowable Power Dissipation	P_{dmax}	1.2	W
		50 x 50 x 1.5mm ³ Cu-coated	2.25 W
Operating Temperature	T_{opr}	-20 to +75	°C
Storage Temperature	T_{stg}	-40 to +150	°C

Recommended Operating Conditions at $T_a=25^\circ C$

Supply Voltage	V_{CC}	6 to 9	V
Load Resistance	R_L	3.2 to 8	ohm

Operating Characteristics at $T_a=25^\circ C, V_{CC}=6V, f=1kHz,$

	See specified Test Circuit.					
Quiescent Current	I_{CCO}	$V_{CC}=6V$	min	typ	max	unit
			18	30		mA
		$V_{CC}=9V$	23	40		mA
[Preamplifier] Voltage Gain	VG	Open loop		85		dB
		Closed loop, Playback		40		dB
Maximum Output Voltage	v_o	THD=1%, Playback	0.9	1.2		V
Input Resistance	r_i		21	30		kohm
Equivalent Input Noise Voltage	V_{NI}	Playback	1.0	2.0		uV
ALC Input Level	ALC	THD=1%, Playback	-20	-12		dBm

Continued on next page.

Package Dimensions 3005A

(unit: mm)

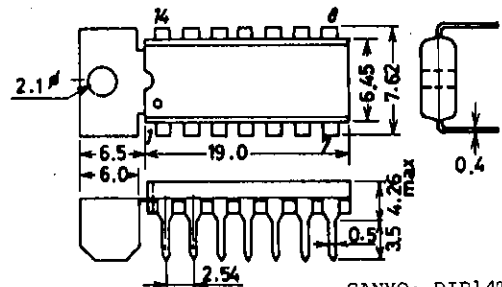

SANYO: DIP14T

Sample Application Circuit 2 : Radio-Cassette Recorder

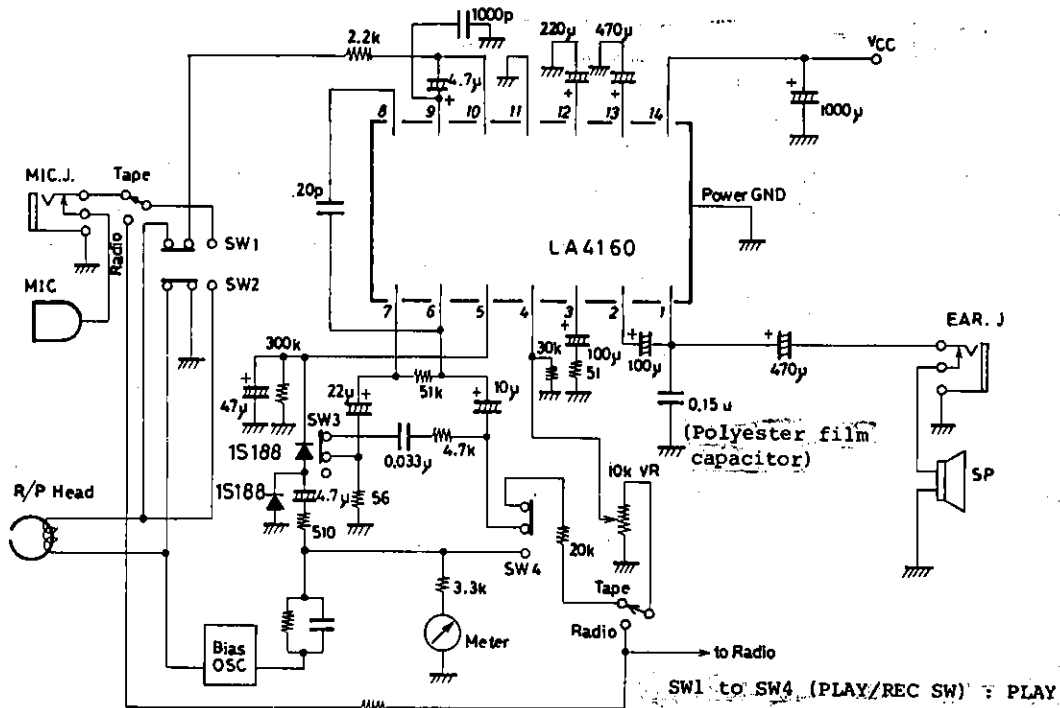

Unit (resistance: Ω, capacitance: F)

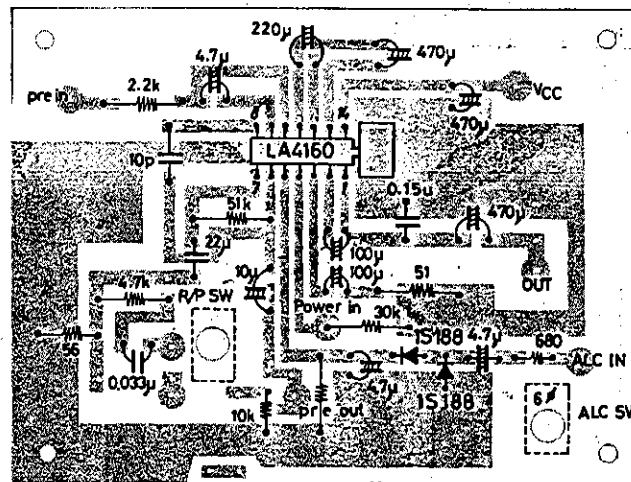

An Example of Printed Board (80 x 105 mm², Cu-foiled side)

Description of Application Circuit

1. Preamplifier

The preamplifier circuit consists of the input differential stage (TR9, 10), level shift stage (TR13), and output stage (TR17, 18, 19). Since the output stage is of push-pull type, no remarkable drop in the output voltage occurs even at low load impedances and the output can be connected direct to the ALC circuit and meter circuit. The external DC/AC feedback resistor (Z2) can be set arbitrarily and the closed loop gain is obtained by the following equation.

$$VG(\text{pre}) = 20 \log\left(-\frac{Z2}{Z1}\right) \text{ (dB)}$$

The input impedance depends on internal resistance R₂ which is 30kohms.

Preamplifier Circuit

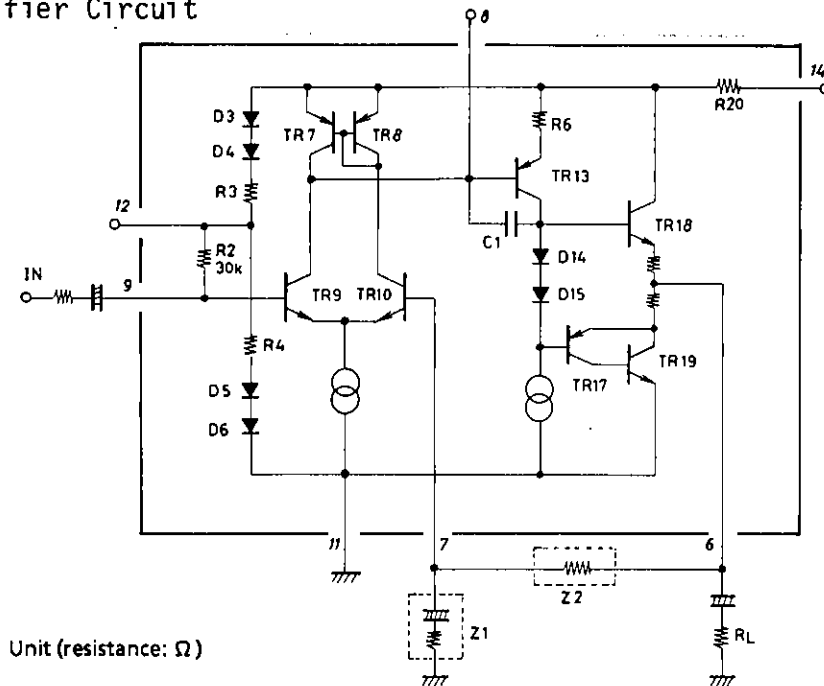

Unit (resistance: Ω)

Since the maximum output voltage for THD=1% drops at less than 600ohms of the composite load impedance viewed from output pin (6), it is desirable to make the composite load impedance more than 600ohms when using this IC. (Refer to V_{Omax} , THD - R_L characteristics.)

2. ALC Circuit

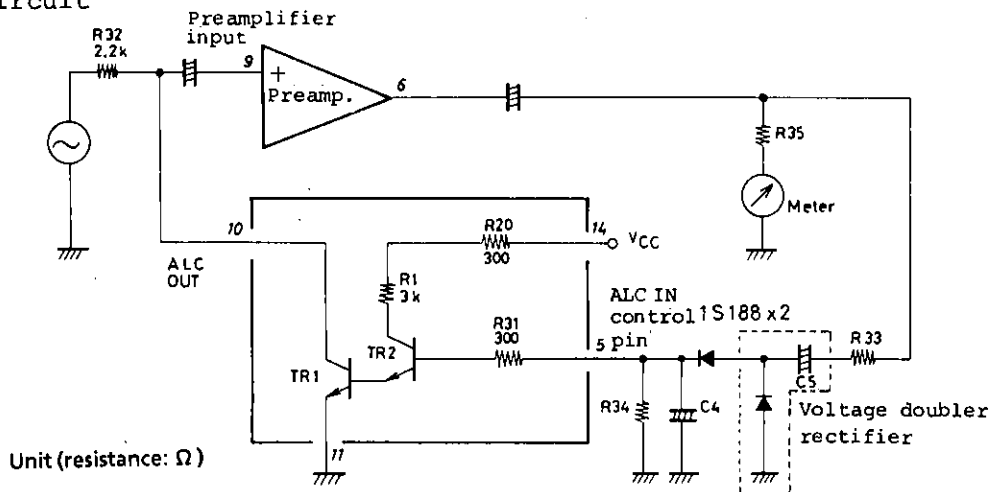

Unit (resistance: Ω)

The ALC circuit is of Darlington configuration which consists of TR1, 2. The collector-to-emitter impedance of TR1 is made variable by the DC voltage to be applied to control pin (5) and the input voltage of the preamplifier is controlled. When the DC voltage to be applied to pin (5) is set at approximately 1.1V, TR1, 2 are turned ON and the ALC is turned ON. For the rectifier circuit, it is recommended to use the voltage doubler rectifier which is excellent in compression ratio. For the sets of 6V V_{CC} , it is recommended to use a germanium diode so that the ALC width can be made wider even at the time of decreased voltages.

3. Power Amplifier

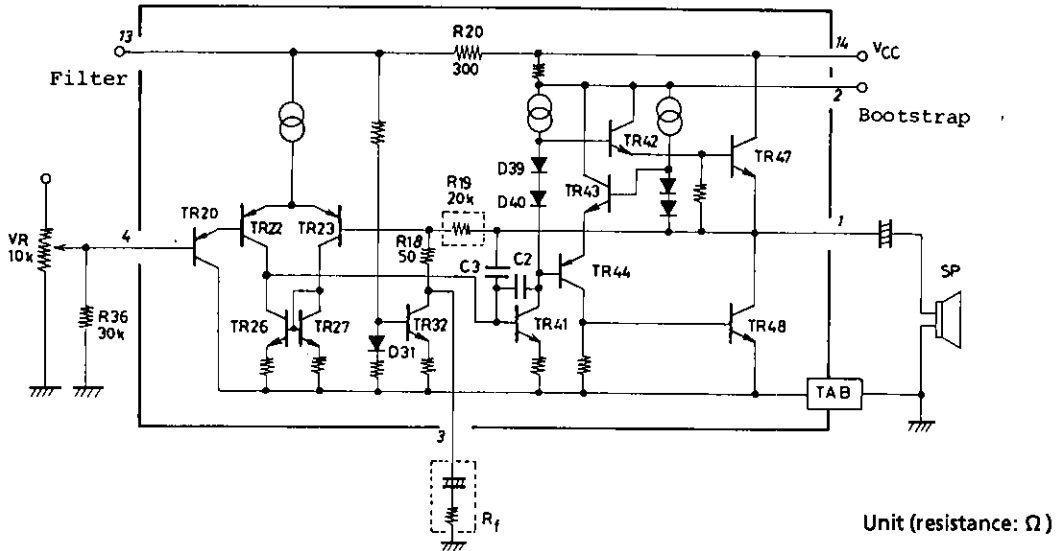

The Power amplifier circuit consists of the differential stage (TR22, 23), predriver stage (TR41), driver stage (TR42, 44), and output stage (TR47, 48). Bias resistor R36 of TR20 at the first stage is attached externally and the input impedance depends on this R36. Input pin (4) whose potential is nearly equal to the ground potential can be connected direct to the variable resistor without using an input coupling capacitor. The closed loop voltage gain is obtained by the following equation.

$$VG(pwr) = 20 \log \left\{ \frac{R19}{(R18+Rf)} \right\}$$

Since R19=20kohms, R18=50ohms are set, approximately 52dB max. is available if Rf=0 is taken.

Proper Cares in Using IC

1. Printed Circuit Board

For the printed circuit board layout, refer to the printed circuit pattern example in principle. It is necessary that the grounding points of the power amplifier input (variable resistor), pin (3) feedback resistor (Rf), and bias resistor (R35) should be adjacent to one another. Especially, it should be noted that if a common impedance exists in the variable resistor grounding, the distortion, residual ripple, and cross interference (leak of signal between preamplifier and power amplifier) may worsen.

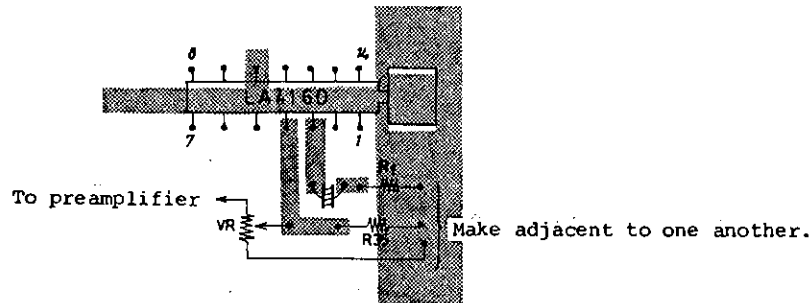

2. Oscillation

a) Preamplifier

Since oscillation may occur when used at a low voltage gain, a capacitor of approximately 10pF must be connected across pins (8) and (6) for phase compensation. If the capacitor connected across pins (8) and (6) has a large capacitance at a low load impedance, further oscillation may occur; and in this case the load pin must be grounded through a capacitor of approximately 0.01 μ F (Polyester film capacitor). The input pin must be grounded through a capacitor of approximately 1000pF for the purpose of prevention of radio disturbance and oscillation.

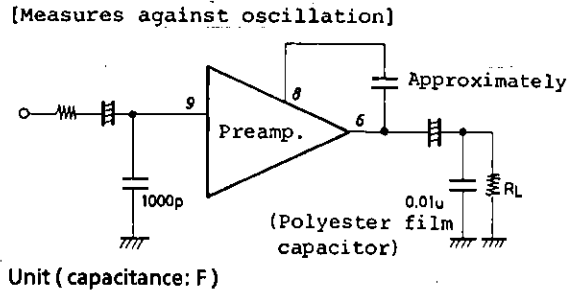

b) Power Amplifier

For the oscillation preventing capacitor connected across output pin (1) and ground, it is recommended to use a polyester film capacitor which is excellent in temperature characteristic and frequency characteristic. It should be noted, however, that if such a polyester film capacitor as to have a resonance point at a high frequency is used oscillation may not be prevented.

3. Shock Noise

The shock noise which occurs from the power amplifier at the time of power supply ON/OFF is reduced by means of the prevention circuit. However, when the starting time of the power amplifier is set earlier than that of the preamplifier or the power supply is turned ON immediately after turning OFF, it may happen that the shock noise of the preamplifier cannot be masked. In this case, a germanium diode should be connected across pins (7) and (9), and pins (7) and (12) respectively to make the starting time as early as possible. Even if no germanium diode is connected across pins (7) and (12), the starting time can be made earlier, but the starting time can be made much earlier by using 2pcs. of germanium diode.

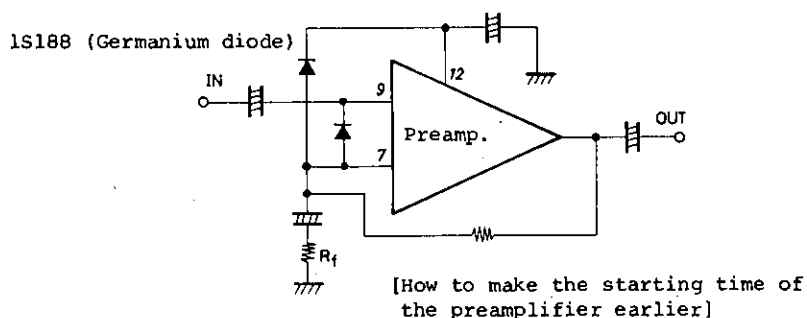

4. Power Supply for Radio's Built-in Capacitor Microphone

Pin (13) is for the low ripple power supply. This pin cannot be used as the power supply for a block, such as radio, which requires a large amount of current. The reason for this is that if this pin is used for this purpose, the middle point of the power amplifier shifts, thereby causing the drop in output. However, this pin can be safely used as the power supply for a built-in capacitor microphone.

5. Recording Muting

The recording muting at the time of recording by use of the built-in microphone is enabled by applying 1 to 5 V DC voltage to feedback pin (3) of the power amplifier. (Power amplifier : Cutoff)

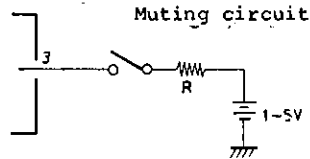

6. In case of using in a radio-cassette recorder, the IC and the bar antenna must be arranged sufficiently distant from each other to avoid the radiation of higher harmonic component at the time of output saturation of the power amplifier.

7. Pin-to-pin short causes breakdown and deterioration.

8. Load short causes breakdown and deterioration of both preamplifier and power amplifier.

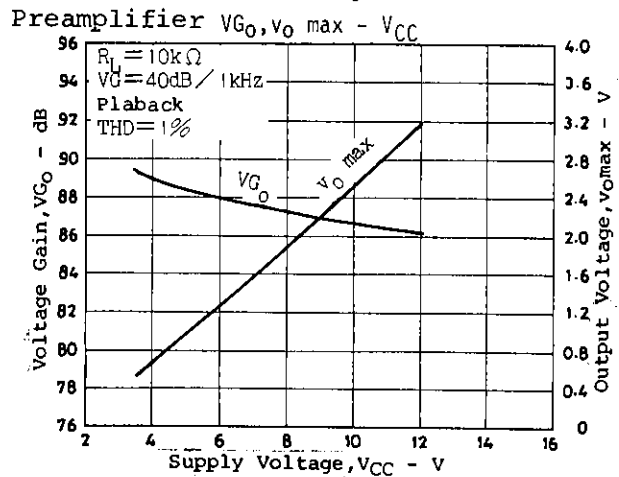
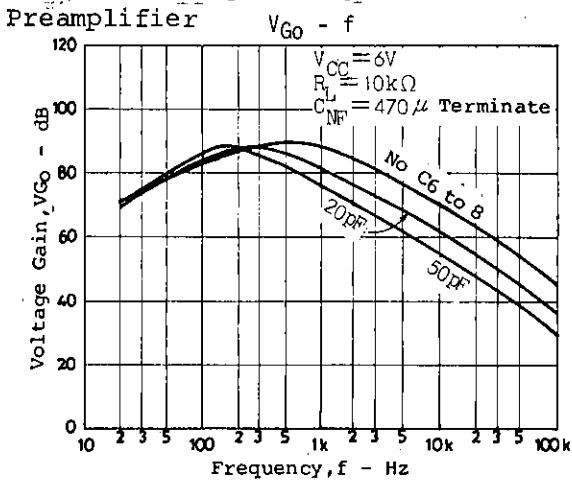
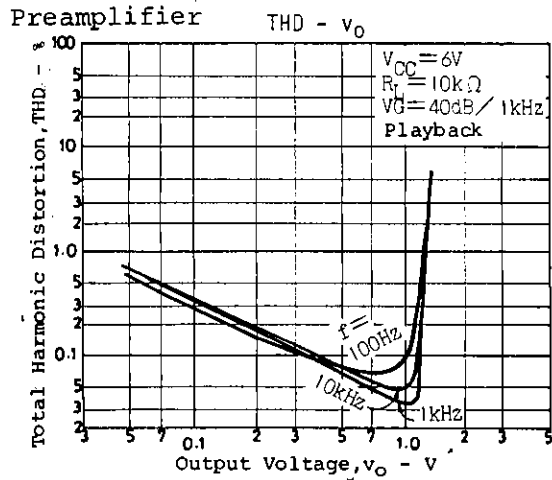
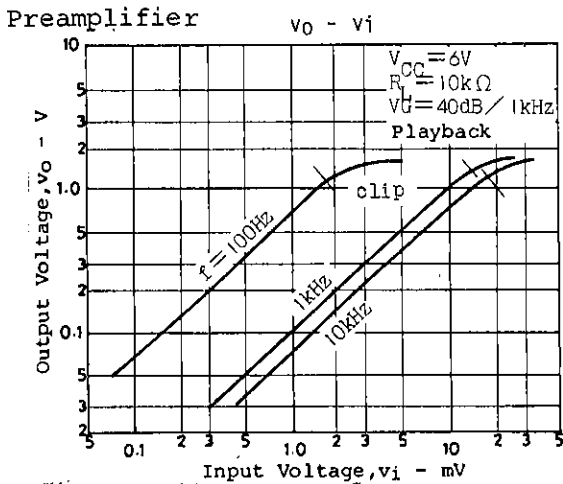

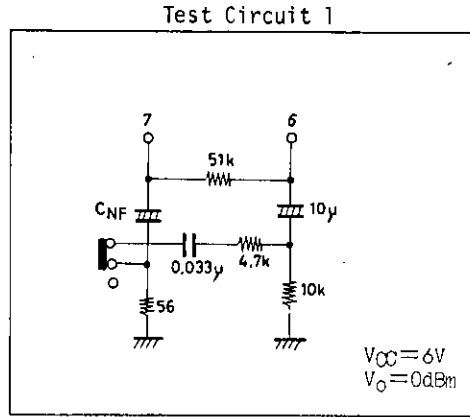
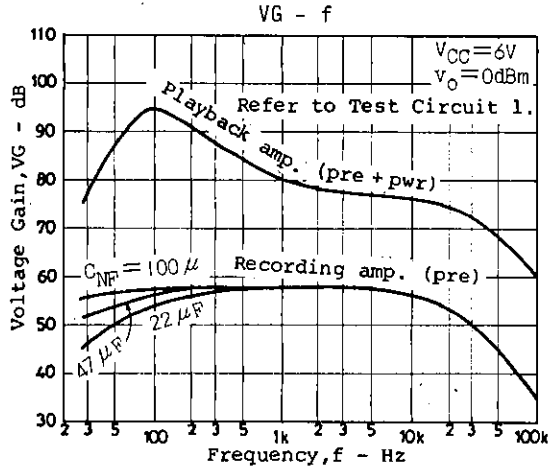

Unit (resistance: Ω , capacitance: F)

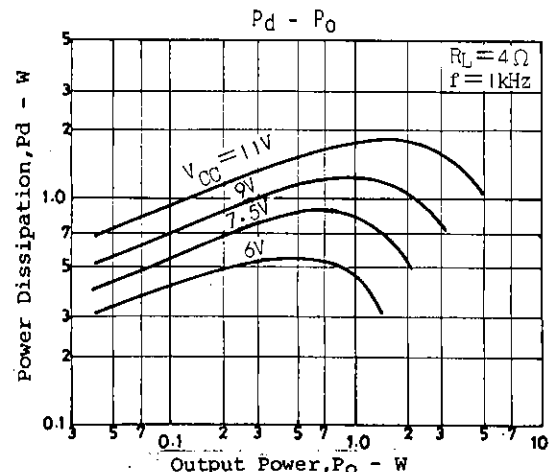
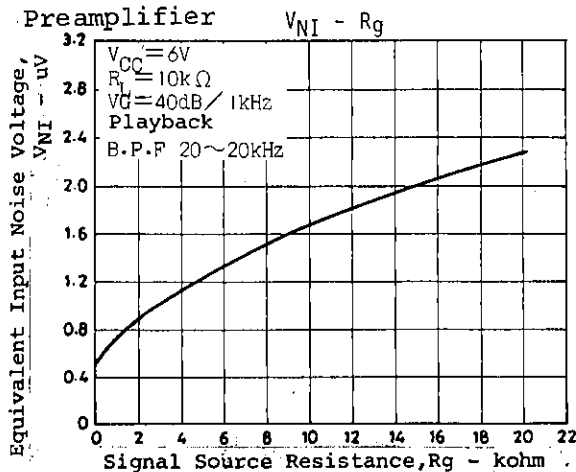
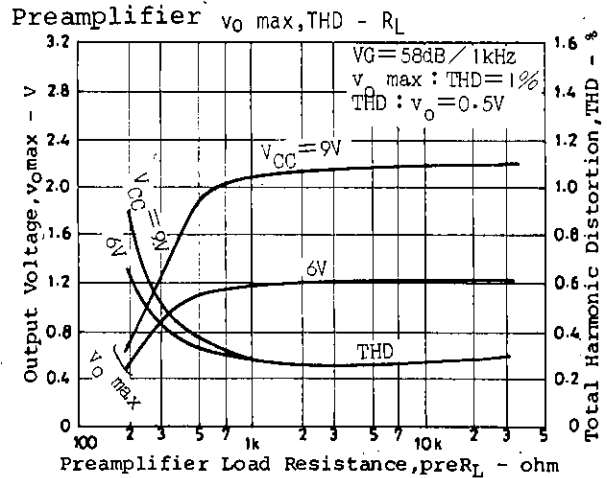
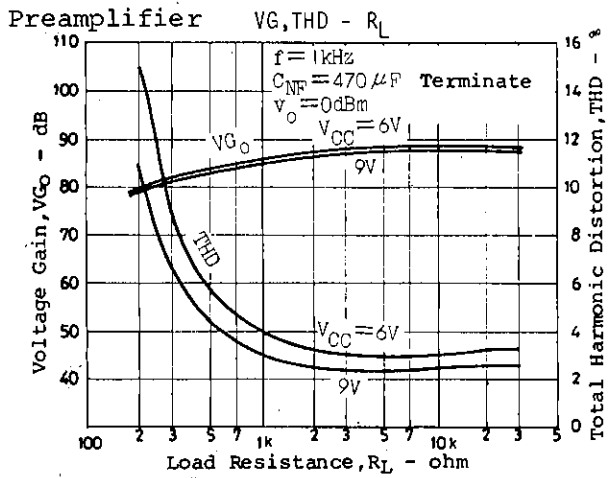
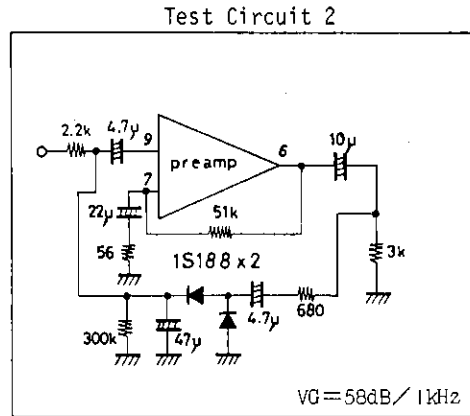
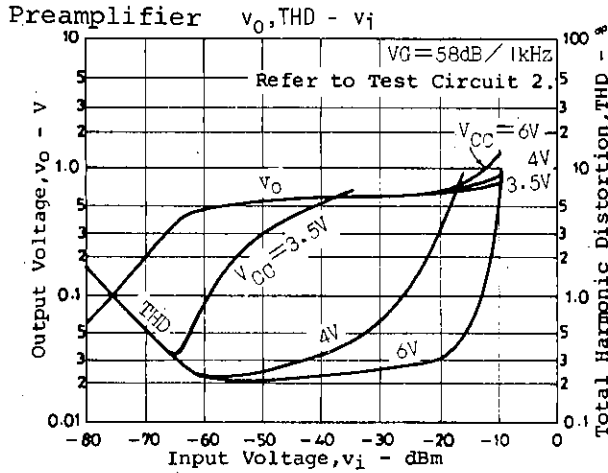

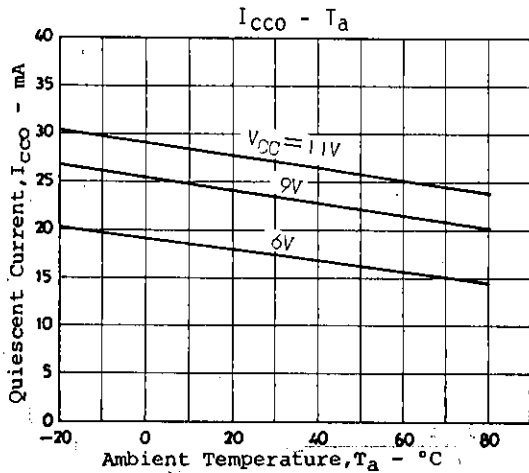
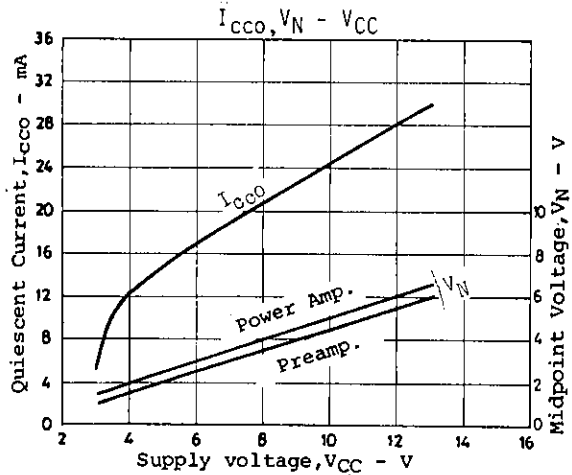
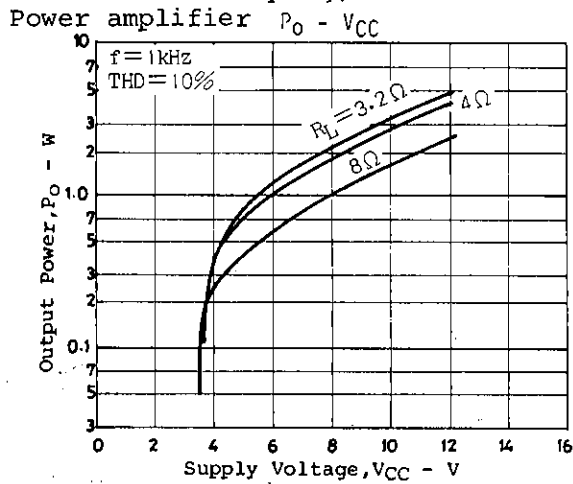
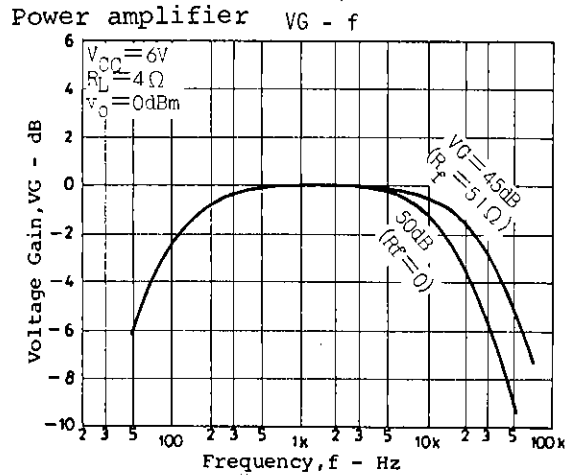
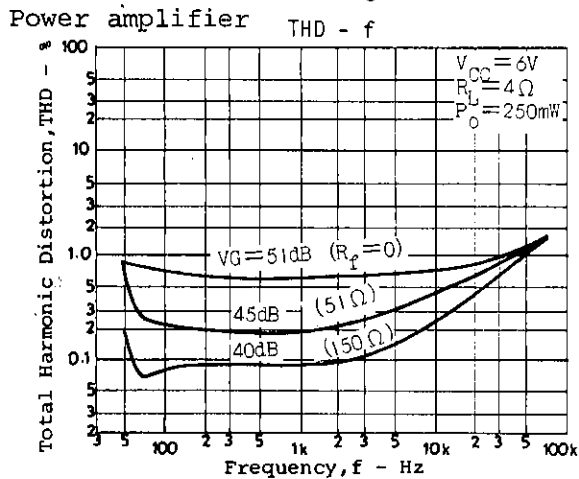
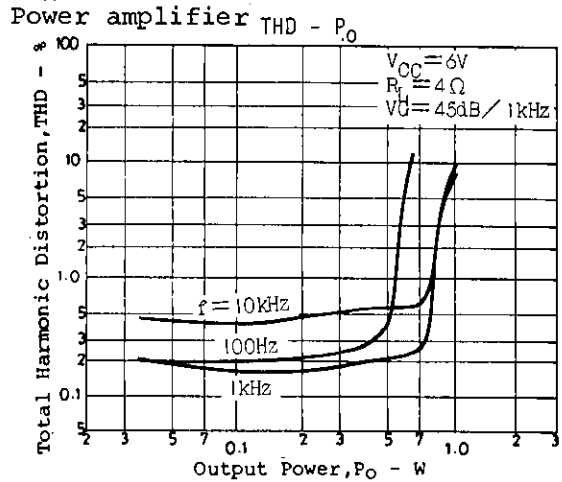
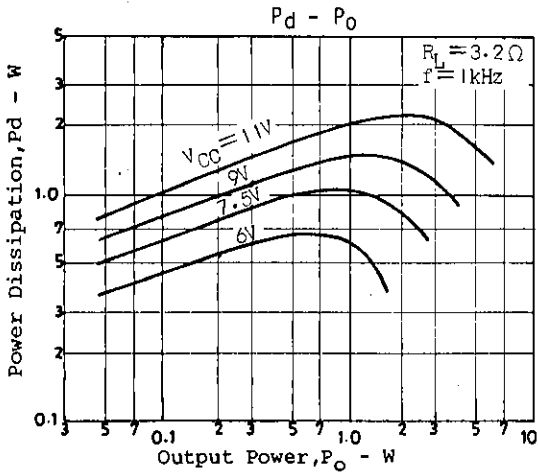

- No products described or contained herein are intended for use in surgical implants, life-support systems, aerospace equipment, nuclear power control systems, vehicles, disaster/crime-prevention equipment and the like, the failure of which may directly or indirectly cause injury, death or property loss.
- Anyone purchasing any products described or contained herein for an above-mentioned use shall:
 - ① Accept full responsibility and indemnify and defend SANYO ELECTRIC CO., LTD., its affiliates, subsidiaries and distributors and all their officers and employees, jointly and severally, against any and all claims and litigation and all damages, cost and expenses associated with such use:
 - ② Not impose any responsibility for any fault or negligence which may be cited in any such claim or litigation on SANYO ELECTRIC CO., LTD., its affiliates, subsidiaries and distributors or any of their officers and employees jointly or severally.
- Information (including circuit diagrams and circuit parameters) herein is for example only; it is not guaranteed for volume production. SANYO believes information herein is accurate and reliable, but no guarantees are made or implied regarding its use or any infringements of intellectual property rights or other rights of third parties.